

# VEGA

AFFORDABLE ROYALTY



## DESIGNED FOR **PERFORMANCE**

Premium Quality uPVC Profiles

[vegaupvc.com](http://vegaupvc.com)

# ABOUT **VEGA**

At VEGA, we focus on crafting profiles that offer exceptional durability, thermal insulation, sound-proofing, and low maintenance, while elevating the aesthetic value of every space. With state-of-the-art manufacturing and a commitment to global standards, VEGA is set to redefine living and working environments with smart, sustainable, and stylish uPVC systems.

Backed by over 20 years of industry experience, VEGA uPVC enters the market with a strong foundation in quality, innovation, and customer trust. Our team of seasoned professionals brings deep expertise in designing and delivering high-performance uPVC window and door solutions that meet the evolving needs of modern construction.



## VISION

To be India's most trusted uPVC window and door brand, known for quality, transparency, and customer-centric values.

## MISSION

To build smarter, safer, and more energy-efficient living spaces through innovative uPVC products and excellent customer service.

## VALUES

Integrity  
Innovation  
Quality  
Sustainability  
Customer Focus



# OUR **ADVANTAGES**

**Premium uPVC  
profiles crafted for  
comfort, security and  
long-term  
performance - all  
while adding elegance**

VEGA uPVC profiles are designed to deliver unmatched performance, style, and reliability.

---

Combining advanced technology with precision engineering, VEGA offers superior benefits such as high weather resistance, thermal and acoustic insulation, long-lasting durability, and low maintenance. With a focus on quality and innovation, VEGA ensures every product enhances both the functionality and aesthetics of modern living spaces.

## **Energy Efficiency**

VEGA uPVC windows offer excellent thermal insulation, helping you maintain a comfortable indoor temperature year-round. Stay cool in summer and warm in winter while reducing your energy bills.

## **Low Maintenance**

Built to last, VEGA windows resist rust, termites, and fading. With minimal upkeep required, a simple occasional wipe is all it takes to keep them looking like new.

## **Noise Insulation**

Enjoy a quieter, more peaceful space with VEGA's advanced sealing system that effectively reduces external noise - perfect for urban homes and offices.

## **Weatherproof Performance**

Designed to withstand harsh climates, VEGA windows offer superior protection from rain, wind, and intense sunlight, ensuring comfort in every season.

## **Eco-Friendly Choice**

Manufactured using 100% recyclable uPVC, VEGA windows are an environmentally conscious solution that supports sustainable living.

## **Cost-Effective Investment**

From energy savings to long-lasting performance and low maintenance, VEGA uPVC windows deliver excellent value, making them a smart, long-term investment for your property.



# OUR **PRODUCTS**

## **CASEMENT SERIES**

The VEGA Casement Series is designed for maximum ventilation and unobstructed views. With outward or inward opening options, these windows offer excellent sealing against dust, noise, and weather. Ideal for modern and traditional spaces alike, they combine functionality with a timeless look.



## **SLIDING SERIES**

The VEGA Sliding Series is perfect for spaces where saving room is essential. Smooth glide operation, sleek profiles, and wide openings make these windows a great choice for contemporary homes and commercial setups. Engineered for effortless operation and long-lasting performance.



## COMBINATION SERIES

The VEGA Combination Series merges casement, sliding, and fixed window styles to suit diverse architectural needs. Whether you need larger openings, better light entry, or enhanced design flexibility, this series offers versatile solutions tailored to your space.



## SPECIAL SERIES

The VEGA Premium Range features designer windows like slide & fold, lift & slide, tilt & turn, and arch windows, crafted for luxury projects and high-performance environments. These windows not only elevate aesthetics but also deliver superior insulation, security, and user convenience.



# SLIDING SERIES - 60

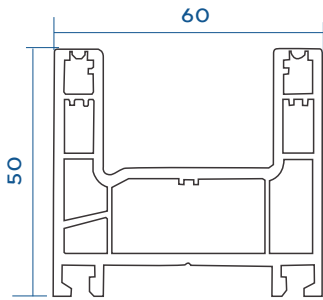

2 Track Sliding Outer Frame  
VGS-620-F01

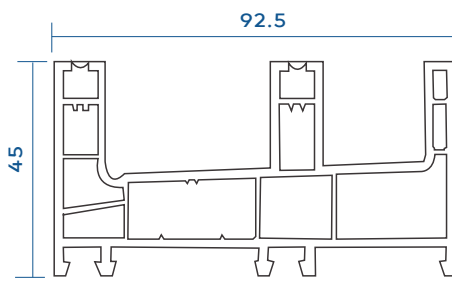

Sliding Outer Frame 2.5 Track With Mesh  
VGS-620-F02

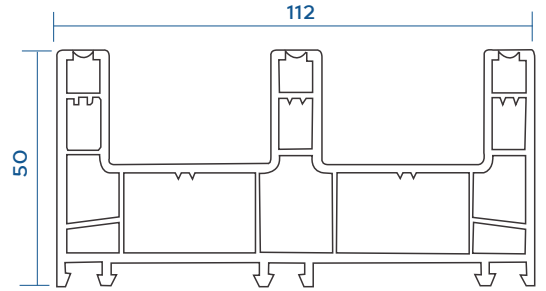

Sliding Outer Frame 3 Track  
VGS-620-F03

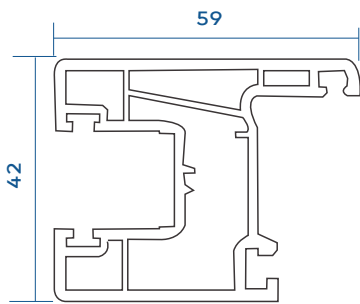

Sliding Window Sash With Gasket  
VGS-621-S01

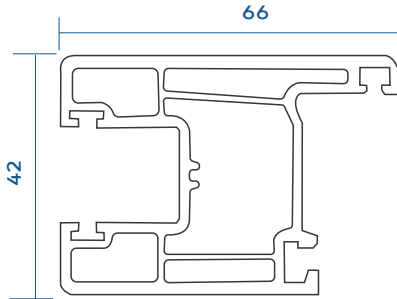

Sliding Window Super Sash With Gasket  
VGS-621-S02

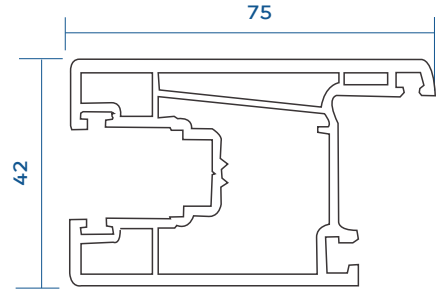

Sliding Super Big Sash With Gasket  
VGS-621-S03

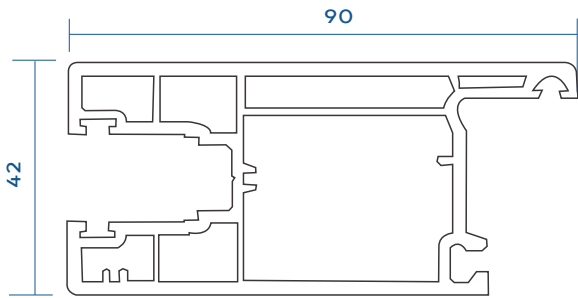

Sliding Door Sash With Gasket  
VGS-621-S04

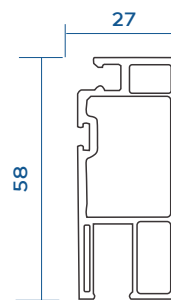

Sliding Window/Door Mesh Sash  
VGS-621-M01

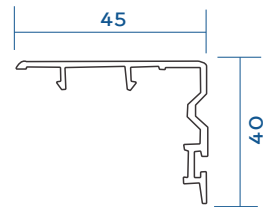

Sliding Inter Lock  
VGS-621-L01

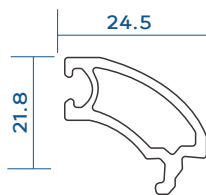

Sliding Single Glazing Arch  
Bead 5/6 MM With Gasket  
VGS-181-B01

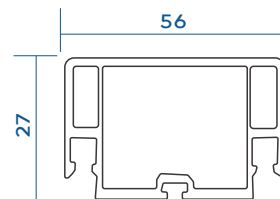

Mesh Mullion  
VGA-620-MT1

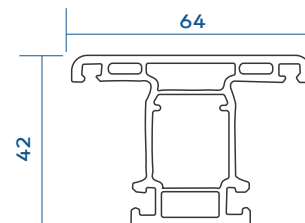

Sash Mullion  
VGA-620-T01



# CASEMENT SERIES - 60

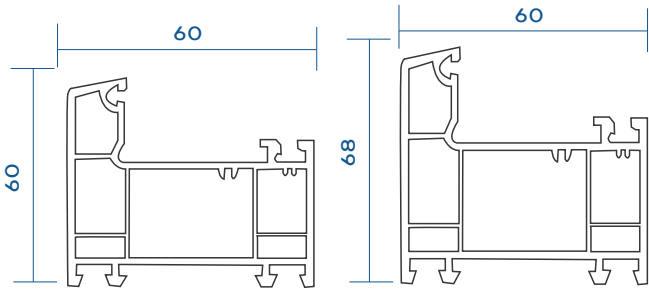

Casement Window Outer Frame With Gasket  
VGC-601-F01

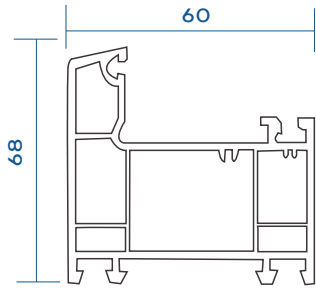

Casement Door Outer Frame With Gasket  
VGC-601-F02

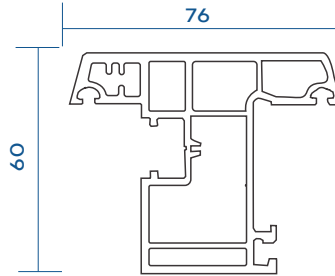

Casement Outward Opening Window Sash With Gasket  
VGC-601-S01

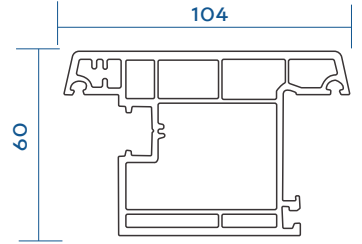

Casement Outward Opening Door Sash With Gasket  
VGC-601-S02

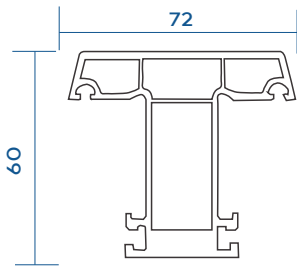

Casement T Mullion  
VGC-601-T01

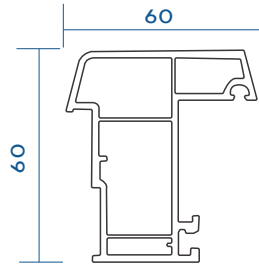

Fly Mullion  
VGC-601-T02

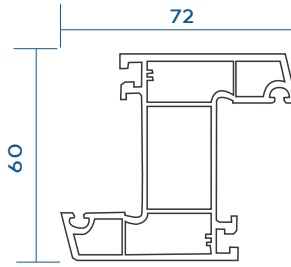

Z Mullion  
VGC-601-T03

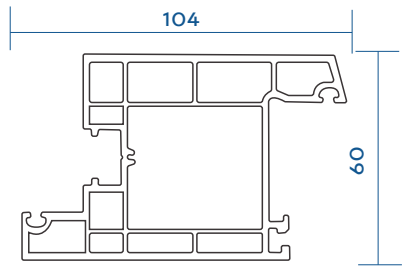

Inward Door Sash  
VGC-601-S03

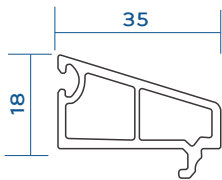

Casement Single Glazing Bead 5/6 Mm With Gasket  
VGC-181-B02

# CASEMENT SERIES - 50

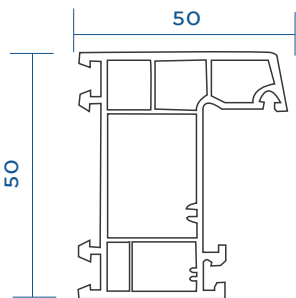

Casement Window Outer Frame With Gasket  
VGC-501-F01

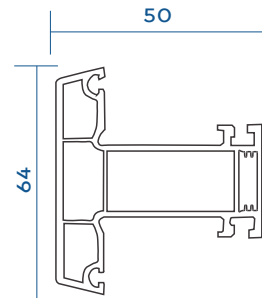

Casement T Mullion With Gasket  
VGC-601-T02



# SLIDING SERIES - 50

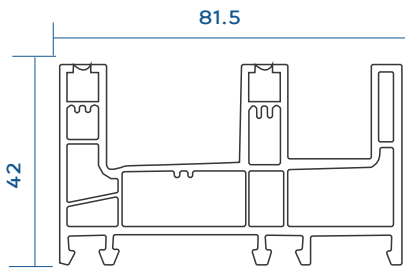

Sliding Outer Frame  
2.5 Track With Mesh  
VGS-500-F02

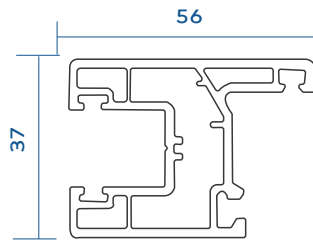

Sliding Window Sash  
With Gasket  
VGS-501-S01

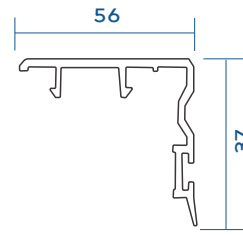

Sliding Inter Lock  
VGS-500-L01

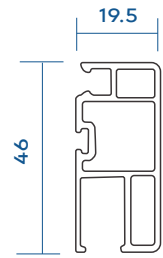

Sliding Window  
Mesh Sash  
VGS-500-M01

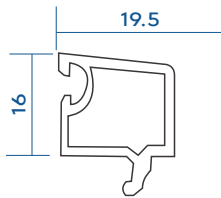

Sliding Single Glazing Bead  
5/6 Mm With Gasket  
VGS-181-B02

# AUXILIARY PROFILES

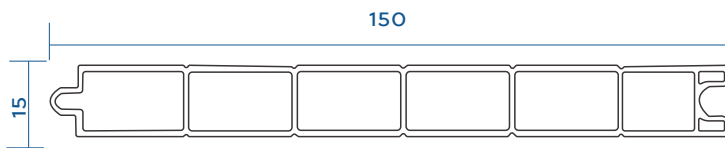

Panel 15 Mm Profile 150 Mm  
VGA-160-A02

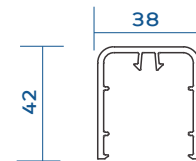

Hurricane Bar  
VGA-160-A03

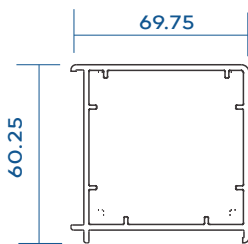

Square Corner  
VGA-160-A04

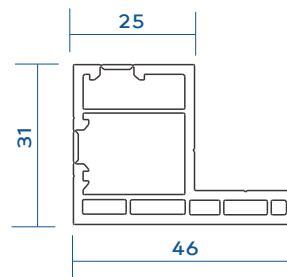

Grill Frame  
VGA-160-A01

# DIFFERENTIATORS

At VEGA, we are committed to delivering high-performance uPVC profiles by integrating cutting-edge machinery, superior raw materials, and rigorous quality control processes. Our advanced extruders and precision-engineered moulds ensure uniform mixing and exact profile dimensions with a flawless surface finish. We source only the finest raw materials from globally trusted suppliers, each batch thoroughly tested before entering production.

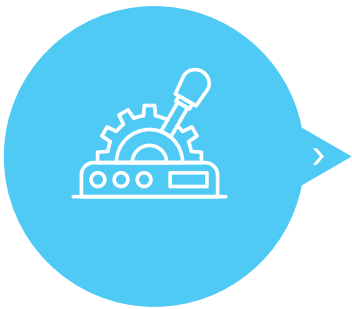

## SOPHISTICATED MACHINERY

Our advanced extruder systems ensure a consistent and precise blend of raw materials. With high-precision moulds and dies, we achieve 100% dimensional accuracy and a superior surface finish in every profile we produce.

## PREMIUM RAW MATERIALS

VEGA Profiles are crafted from top-grade raw materials sourced from globally trusted suppliers. Each batch undergoes stringent quality checks before entering production. We partner only with the best to guarantee consistent product excellence.



## STRINGENT QUALITY CONTROL

Every profile undergoes rigorous quality testing in line with industry standards. We also ensure color consistency using spectrophotometers.

**Tests include:** Impact strength | Density | Welding strength | Heat reversion | Falling mass test (cold impact) | Vicat softening temperature | Surface finish (gloss meter).



## OUR **USPs**

Manufactured in compliance with European Standard EN 12608-1:2016, our profiles are:

- Lead-free and RoHS compliant for environmental safety
- Formulated with 5 PHR Titanium Dioxide for superior color stability
- Equipped with TPE gaskets for enhanced sealing and flexibility
- Designed with high UV resistance to withstand harsh weather conditions



# COLOUR OPTIONS

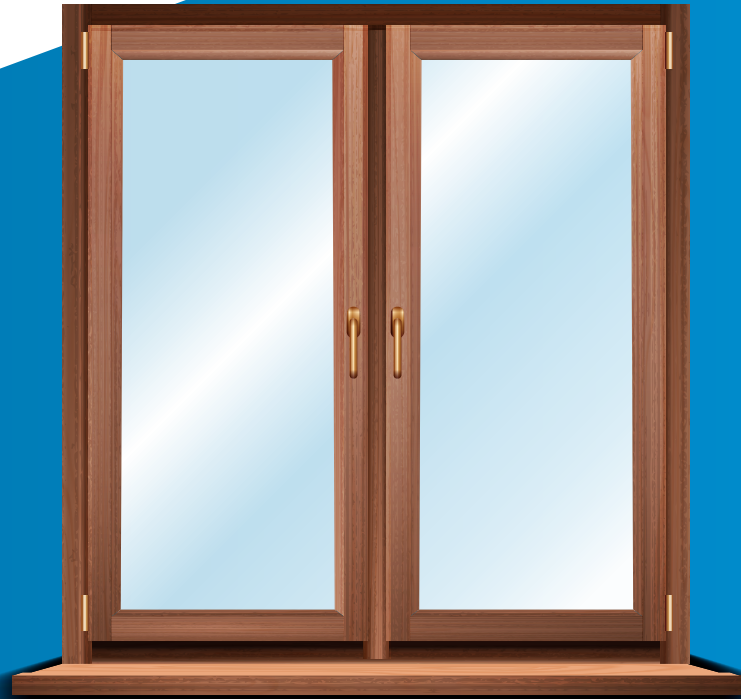

Laminated uPVC window profiles combine the strength and durability of uPVC with elegant woodgrain or textured finishes, offering the perfect balance of performance and aesthetics. Designed to withstand extreme weather conditions, these profiles provide excellent insulation, UV resistance, and long-lasting color stability—making them an ideal choice for modern, stylish, and energy-efficient windows.



Golden Oak



Walnut



Mahogany



Grey



Black

# VEGA

AFFORDABLE ROYALTY

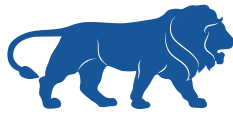

Make in India

**VEGA uPVC Profiles:**

Shed No 15, Survey No. 376/A Prasanthi Nagar,  
Kukatpally. Hyderabad. Pin: 500072

**M:** +91 88868 02789 | +91 99491 86534

**E:** [enquiry@vegaupvc.com](mailto:enquiry@vegaupvc.com)



[vegaupvc.com](http://vegaupvc.com)